

Donaldson®  
Torit®

**DUST, FUME & MIST**  
Collectors, Filters  
& Replacement Parts



# THE MARKET LEADER

## FOR LONG-TERM VALUE

For decades, Donaldson® Torit® has offered manufacturers advanced and reliable dust, fume and mist collectors and filters engineered to provide outstanding filtration efficiency and energy savings. The pairing of these industry-leading collectors and filters helps increase manufacturing efficiencies and cleaner environments for employees.

When efficiency is maximized and employees are at their peak, so is the manufacturer's productivity—and ultimately, its bottom line. Donaldson Torit products can help safeguard that bottom line with innovative collectors and filters, expertly engineered by its unparalleled team of R&D engineers to provide long-term value, rather than short-term savings.

No other dust collection manufacturer can match Donaldson Torit's filtration solutions in delivering clean air.

## SUPERIOR PERFORMANCE

Integrated collectors and filter media work together to offer the highest levels of efficiency and maximize productivity.

## CONTINUALLY EVOLVING FILTRATION SOLUTIONS

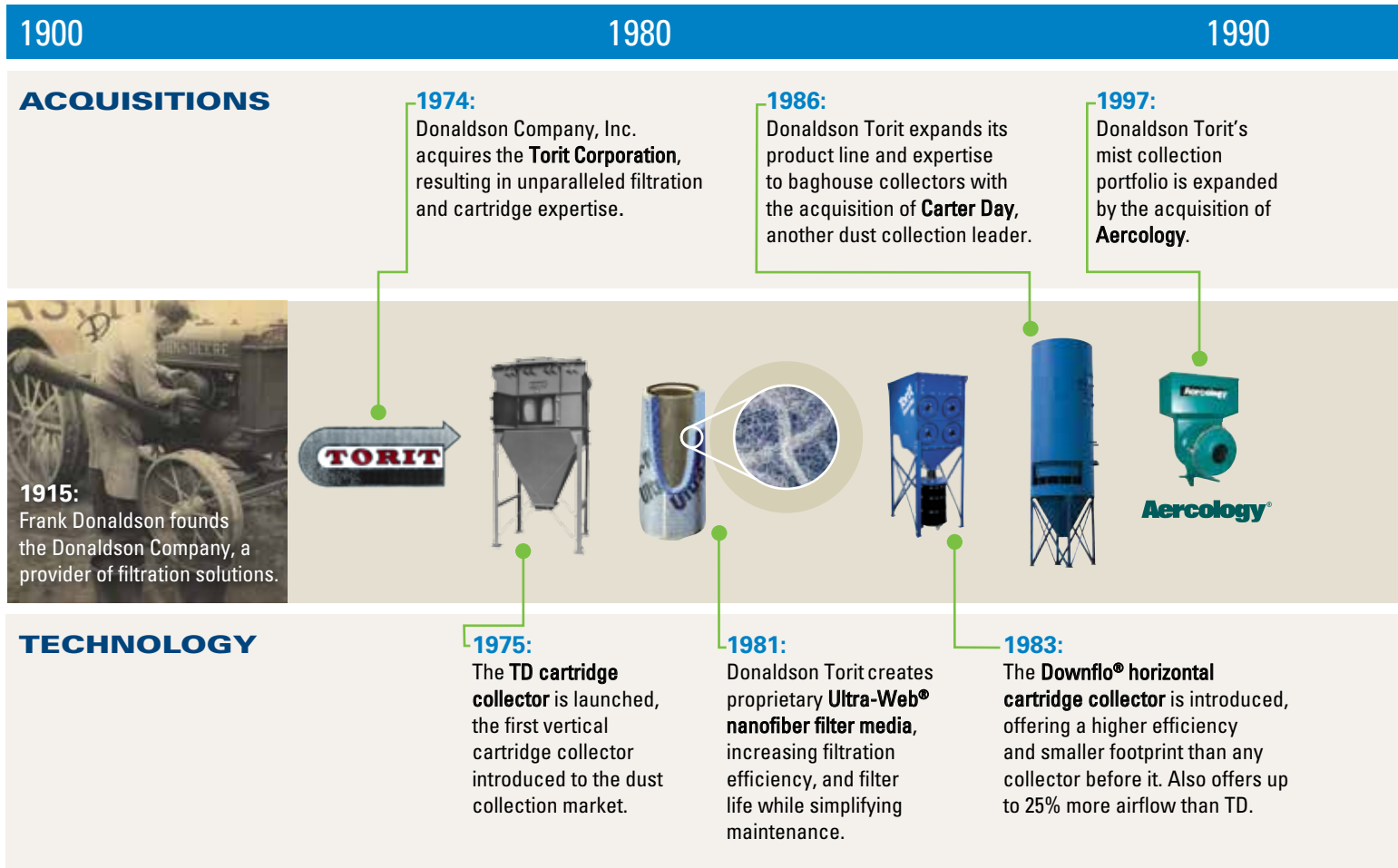

## ADVANCED TECHNOLOGY

As the inventor of the cartridge collector, Donaldson® Torit® has led the way for continuous innovation with award-winning products such as Torit® PowerCore® dust collectors and filter packs.

Proprietary Ultra-Web® nanofiber filter media – the first of its kind – was developed by Donaldson. On the market for three decades, this media technology increases filtration efficiency and simplifies maintenance.

## RELIABILITY

The leading worldwide provider of advanced filtration technology for almost 100 years.

## CUSTOMER SUPPORT

Unmatched service and support at all stages—from up-front engineering to knowledgeable field resources to after-sales service. Worldwide support to provide customers with advanced solutions and service, no matter the location.

2000

2005

2010

**2000:**

Donaldson acquires **DCE**, expanding its baghouse portfolio.



**2004:**

Donaldson Torit offers a full line of replacement filters for competitor brands.



**2005:**

Donaldson Torit introduces Ready2Ship, a service that ships replacement filters within 24 hours of ordering.



**2008:**

Donaldson Torit acquires **LMC-West** and further expands its baghouse portfolio.



**2000:**

**Downflo® Oval 1™** is launched providing up to 25% more airflow than competing collectors and DFT.



**2003:**

**Dura-Life™ bag filters** are introduced—providing increased efficiency and twice the life over standard polyester bags.



**2006:**

**Synteq XP™ Media Technology** is introduced, an advanced media with higher efficiency and superior draining function for the collection of aerosolized mist.



**2008:**

**Torit® PowerCore®** is launched – collectors that are up to 70% smaller and use compact filter packs, resulting in reduced maintenance costs.



# TORIT® POWERCORE® COLLECTORS

## SMALLER. SMARTER.

Torit® PowerCore® dust collectors with PowerCore® filter packs solve the industry's need for better filtration, reduced operational cost, a smaller footprint and easier maintenance. Less steel and oil are required to manufacture and transport collectors that are 50 - 70 percent smaller than traditional collectors. Clean-side filter pack access and fewer, lighter filter packs mean faster, easier filter changes without tools or filter cages. An optimized airflow management system delivers optimal pulse cleaning while minimizing airflow restriction. Also, collectors are shipped with filter packs installed.

Additionally, smaller sized Torit® PowerCore® collectors can eliminate the need for complicated ductwork or a large, energy-consuming central dust collection system. With greater flexibility, manufacturers can now optimize space on the plant floor while containing costs. Innovative PowerCore® filtration technology means reduced freight and installation costs, fewer filter pack changeouts, lower maintenance costs, and no entry requirements for filter pack changes.



(13,600 cfm collectors)  
Torit PowerCore VH 2-8  
vs. Traditional (162) 8-ft  
Filter Baghouse



(5,000 cfm collectors)  
Torit PowerCore CPC-12  
vs. Traditional (81) 8-ft.  
Filter Baghouse

UP TO | **70%  
SMALLER**  
THAN TRADITIONAL DUST COLLECTORS



(5,500 cfm collectors)  
Torit PowerCore TG4  
vs. Traditional  
8-Column Filter  
Collector



(1,500 cfm collectors)  
Torit PowerCore CPV-3  
vs. Bin Vent with  
Traditional (16) 6-ft. Bags

### VH Series

(5,000 - 40,800 cfm)  
(8,493 - 69,305 m³/h)

Specifically designed to handle abrasive dusts in the mining market and grinding and blasting applications in the metalworking market.

Filters are easily removed from the side of the collector without entering a confined space.

### CPC Series

(700 - 33,000 cfm)  
(1,189 - 56,055 m³/h)

A stand-alone collector that can be ducted to many different applications including grain, wood dust, plastic cutting, and food.

Tool-free filter changeout accessed on the clean side of the collector is faster and easier than a traditional baghouse collector.

### TG Series

(960 - 13,440 cfm)  
(1,631 - 22,830 m³/h)

Designed for thermally generated metalworking applications like welding, laser and plasma cutting, and thermal spray.

No tools required T-Handles provide immediate access to the easy-grip PowerCore filter packs.

### CPV Series

(450 - 8,200 cfm)  
(764 - 13,929 m³/h)

Bin vent collector designed for use in material-handling applications – even in tight spaces – including silos, conveyor transfer points, conveyor discharges, blenders, and mixers.

# POWERCORE® MEDIA TECHNOLOGY

## LEADING THE WAY WITH POWERCORE

PowerCore® media technology is integral to the dramatic downsizing of the Torit® PowerCore® collector. PowerCore® filter packs combine Ultra-Web® nanofiber technology with Donaldson's media configuration expertise, creating a new filtration structure unlike anything else in the industrial air filtration market. As a result, a more effective filtration area is packaged into smaller spaces. And just one Torit® PowerCore® filter pack replaces multiple cartridge or bag-style filters. With more media packed into a smaller space and a simplified airflow path, PowerCore® filter packs provide high performance with a low pressure drop.

## HIGH PERFORMANCE FILTER MEDIA

- One Torit PowerCore filter pack replaces multiple cartridge or bag-style filters
- Fast and easy filter pack changes
- Reduced maintenance
- High filtration efficiency for reduced emissions
- Reduced freight & installation costs
- Technology proven in field applications for more than 10 years



**PowerCore®**  
A Donaldson Filtration Technology

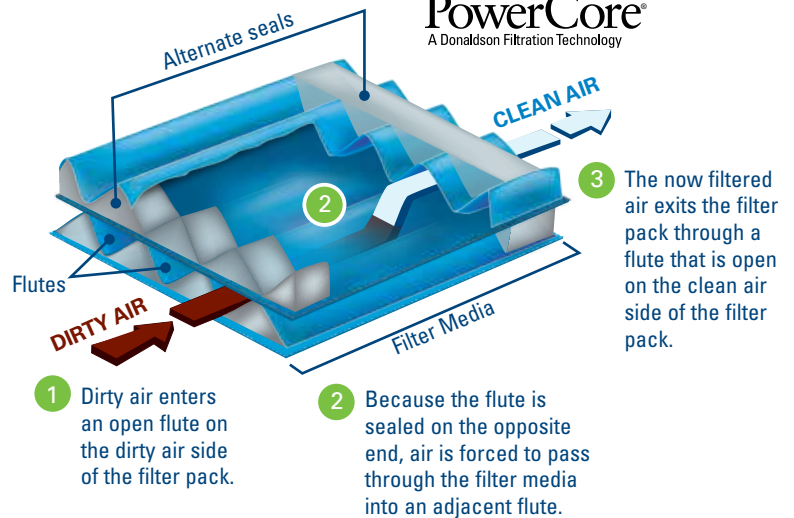

**ONE** POWERCORE FILTER PACK

**REPLACES UP TO**

**CP**  
filter pack



**SIX** 8-ft. long bag filters

**TG**  
filter pack



**THREE** cartridge filters

**VH**  
filter pack



**TWENTY** 8-ft. long bag filters

# CARTRIDGE COLLECTORS

## THE INVENTOR OF THE CARTRIDGE COLLECTOR

As the inventor of the cartridge collector, Donaldson® Torit® has led the way with continuous innovation, such as the award-winning Downflo® Oval dust collection technology. No other manufacturer comes close to matching the innovation and breadth of technical expertise that Donaldson Torit incorporates into its cartridge collectors.

Donaldson Torit engineers its cartridge collectors to capture the broad spectrum of dust particles that can inhibit the production environment. From portable to central collectors, to source and ambient collectors, to booth-type collectors and weld benches, Donaldson Torit provides the most complete range of cartridge collectors that cost-effectively enhance productivity and manufacturing efficiency.



### Downdraft Bench

(700 - 3,000 cfm)  
(1,189 - 5,096 m³/h)

Self-contained dust collector bench for grinding and finishing operations.

### Downflo® WorkStation

(4,500 - 22,000 cfm)  
(7,644 - 37,370 m³/h)

Designed specifically for in-plant areas where dirty and/or noisy operations are out in the open – grinding, sanding, chipping, batch mixing or welding.

### Downflo® Oval

(90 - 102,000 cfm)  
(153 - 173,262 m³/h)

DFO is a one-of-a-kind series of cartridge dust collectors with oval-shaped filter technology, proprietary filter media and pulse cleaning that provides up to 25% more airflow capacity than same-sized round cartridge collectors.

### Downflo® II

(500 - 100,000 cfm)  
(849 - 169,865 m³/h)

A leading cartridge technology for over 20 years, DFT delivers powerful performance and cost savings.

### Fume Collectors

#### AT-3000 T-2000™ Weld Bench

T-2000 (890 cfm)  
(1,512 m³/h)  
WB (2,000 - 3,000 cfm)  
(3,397 - 5,096 m³/h)

T-2000 and AT-3000 ceiling-mount, self-contained source collectors capture fume generated in moderate-to-heavy welding applications. Designed specifically for welding operations, Weld Bench provides high capture velocity that assures fume capture and eliminates the need for extraction arms.

#### Easy-Trunk™ Porta-Trunk™ Extraction Arms

(750 - 780 cfm)  
(1,274 - 1,325 m³/h)

Offering compact, portable filtration of smoke, dust and fumes that result from welding and grinding applications, Easy-Trunk provides built-in manual pulse filter cleaning. Porta-Trunk is a static filter system.

# ULTRA-WEB® MEDIA TECHNOLOGY

## THE INVENTOR OF ULTRA-WEB

Proven for 30 years, advanced and improved many times over, proprietary Ultra-Web is the nanofiber media technology that outperforms all others; it delivers longer filter life, cleaner air, and greater savings.

Donaldson® Torit® offers a complete line of Ultra-Web cartridge filters that last twice as long as or more than commodity cellulose and cellulose/synthetic (80/20) blend medias. The Ultra-Web surface-loading technology is scientifically proven to provide a lower operating pressure drop over a longer period of time, which allows the filter to last longer while requiring less energy.

**ULTRA-WEB  
OUTPERFORMS  
ALL OTHERS**

**10 Micron  
Particulate  
at 600X**

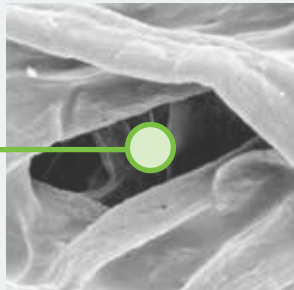
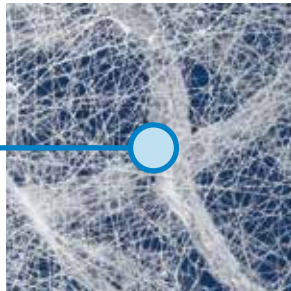

**CELLULOSE**

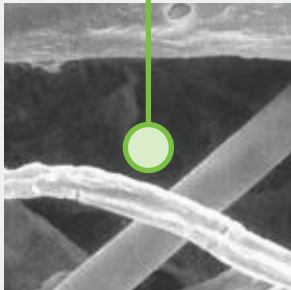

**CELLULOSE/  
SYNTHETIC**

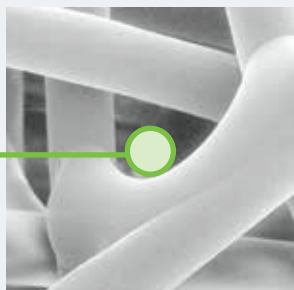

**SPUNBOND**

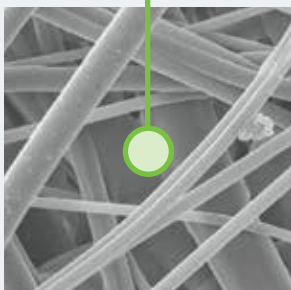

**MELTBLOWN**

1 micron = 1/25,400 of an inch (1/1,000 of a millimeter)

Ultra-Web nanofiber media is the most optimized and cost-effective choice available for most all dust and fume collection applications.

Experience the Ultra-Web advantage:

- Increased surface loading
- Enhanced dust cake release
- Better cleaning efficiency
- Lower cost per cfm
- Available for all popular brands of dust collectors



**ULTRA-WEB®**  
**3 DECADES OF LEADERSHIP &  
OVER 5 MILLION FILTERS SOLD**

# BAGHOUSE COLLECTORS

## THE RIGHT BAGHOUSE FOR THE APPLICATION

Donaldson® Torit® offers a complete line of dependable, rugged baghouse dust collectors ranging from small Cyclones and Unimaster® collectors that handle as low as 120 cfm to large RFs and LPs that handle up to 197,000 cfm. Donaldson Torit also offers unique collectors like the Dalamatric®, which feature envelope-shaped bags for improved pulse cleaning of especially challenging dusts, and **clean side access** to filters to make changeouts easier.

In addition to offering the best baghouses on the market, Donaldson Torit continually develops industry-leading technologies such as Dura-Life™ bag filters that provide longer filter life, increased efficiency, and reduced operating costs.



### RF and LP Baghouse

### Unimaster®

### Dalamatric® Cased – DLMC Insertable – DLMV

### IRD Dust Collector

### Modular Baghouse

(2,000 - 197,000 cfm)  
(3,397 - 334,634 m³/h)

(120 - 10,000 cfm)  
(204 - 16,987 m³/h)

(170 - 85,000 cfm)  
(289 - 144,385 m³/h)

(1,350 - 5,000 cfm)  
(2,293 - 8,493 m³/h)

(1,150 - 65,000 cfm)  
(1,953 - 110,412 m³/h)

The award-winning RF and LP are larger baghouses that combine cyclone style pre-separation and baghouse filters in one collector. They also provide non-compressed air cleaning. The RF uses low pressure cleaning while the LP uses reverse air cleaning.

The UMA is a complete unit that is suited for intermittent duty applications where compressed air is not available. This unit uses a superior shaker design to clean the bags for optimized airflow. Everything needed is packaged in one compact unit (including fan and controls).

The Dalamatric line of collectors uses envelope-shaped bags that provide extra snap during pulsing for use in especially challenging dust applications. The DLMC is a stand-alone collector with hopper, while the DLMV comes without hopper for use in bin venting and transfer point applications.

The IRD is an economical, continuous duty collector for wood dust applications. This easy-to-install collector, complete with fan, comes with everything needed to start clearing the air. Just assemble, hook up ductwork and let it go.

Designed for fast, easy installation and simple, reliable dust collection, Modular Baghouses provide high performance filtration in applications with high air volumes and heavy dust loading.



# DURA-LIFE™ FILTER MEDIA TECHNOLOGY

## FOR TWICE THE LIFE

The most significant advancement in baghouse filter technology is the development of Dura-Life™ bag filters. Bags made from Dura-Life™ media have increased efficiency, longer life, and lower maintenance costs.

Dura-Life media – compared to standard polyester media – is engineered with a unique hydro-entanglement process that uses water to blend the fibers. This process creates a more uniform material with smaller pores, which results in better surface loading and superior cleaning.

### NEEDED POLYESTER BAG Clean Air Side



### DURA-LIFE™ BAG Clean Air Side

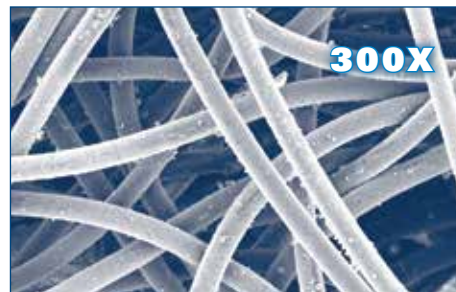

These photos were taken with a scanning electron microscope of bag media used in a collector that was filtering fly ash. Note the amount of dust that embeds into the needed polyester bag compared to Dura-Life™.

## DURA-LIFE™ BAGS PROVIDE BIG BENEFITS

Dura-Life™ technology provides superior surface loading and pulse cleaning, resulting in:

- Two to three times longer bag life
- Energy savings due to lower pressure drop
- Reduced replacement bag costs due to fewer bag changeouts
- Reduced maintenance and operating costs due to fewer bag changeouts
- 30% fewer emissions based on EPA tests
- Available for all popular brands of dust collectors

**DURA-LIFE™**  
Twice The Life Filter Bags

**READY  
2SHIP**



# MIST COLLECTORS

## A COMPREHENSIVE RANGE

High performance mist collection is a must for manufacturers that generate coolant and machining oil mist in their applications. Uncollected mist leaves condensation and residue on floors, machines, walls and ceilings, creating a potentially unsafe and unclean manufacturing environment.

Donaldson® Torit® provides a comprehensive range of mist collectors, each providing the peace of mind manufacturers need to be productive and efficient.

Rely on Donaldson Torit for the most advanced mist collection technology.

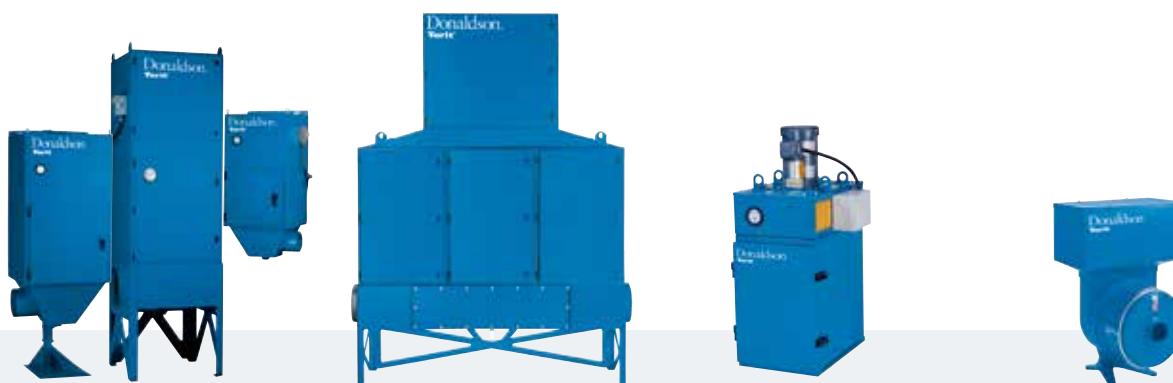

### WSO

LONGEST LIFE OPTION

(450 - 5,550 cfm)  
(764 - 9,428 m<sup>3</sup>/h)

WSO mist collector is the only collector that filters three types of mist (water, smoke, oil) in one collector – simply by tailoring the filter. Designed to collect water-soluble coolant, straight oil, and the most challenging – oily smoke – from a variety of machining operations and other industrial processes. The WSO design has several configurations such as machine mountable, stand mount, ducted cellular and central system to meet your plant requirements.

### Modular MediaFilter™

(1,000 - 6,000 cfm)  
(1,699 - 10,192 m<sup>3</sup>/h)

Modular MediaFilter provides flexible, high performance mist collection for applications such as grinding, wet grinding, wet machining, rubber machining, die casting and soldering. Available in vertical and horizontal models, Modular MediaFilter collectors are expandable to adapt to changing needs such as smoke, dust and fume filtration, saving the cost of a new filtration system.

### Mini-Mist

(300 - 1,200 cfm)  
(510 - 2,038 m<sup>3</sup>/h)

Designed to collect coolant mists from CNC machining, grinding, turning, milling and drilling operations, compact Mini-Mist collectors are effective alone or can be integrated into larger machining operations.

### Centrifugal

(100 - 1,000 cfm)  
(170 - 1,699 m<sup>3</sup>/h)

Centrifugal collectors offer compact, high efficiency and economical mist collection. They can be used to reclaim mist in applications that process petrochemicals or synthetic coolants. They are particularly effective at handling very heavy mist loading concentrations.

# SYNTEQ XP™ MEDIA TECHNOLOGY

## ADVANCED FILTER MEDIA FOR MIST

Proprietary Synteq XP is a revolutionary and proprietary media for mist collection that provides higher efficiency, low operating pressure drop, and longer filter life when compared to traditional media.

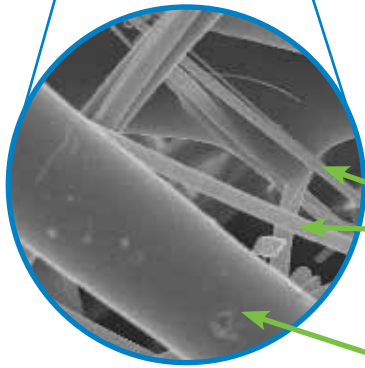
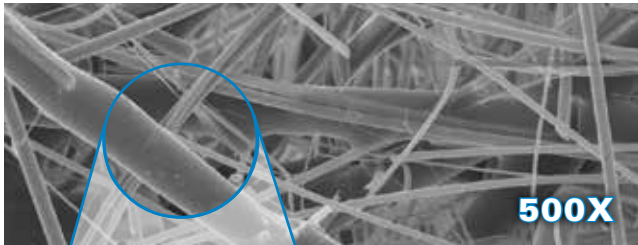

Micro-glass  
for filtration

Bi-component  
binding fiber

During the media manufacturing process, the surface of the binding fiber is heat fused to make it bond to the surrounding micro-glass – no resin webbing to block pores.

### SYNTEQ XP MEDIA WITH RESIN-FREE BINDING FIBERS

- Fast and easy filter pack changes
- Engineered blend of small and large fibers, with proprietary, resin-free bonding system
- Small fibers are scientifically proven to increase efficiency through superior draining
- Large fibers provide structural support and clear drain channels to sustain performance in the most challenging applications
- Proprietary bonding system stabilizes pore structure for optimum performance and longer life
- Available for many brands of mist collectors



# A RANGE OF COLLECTORS

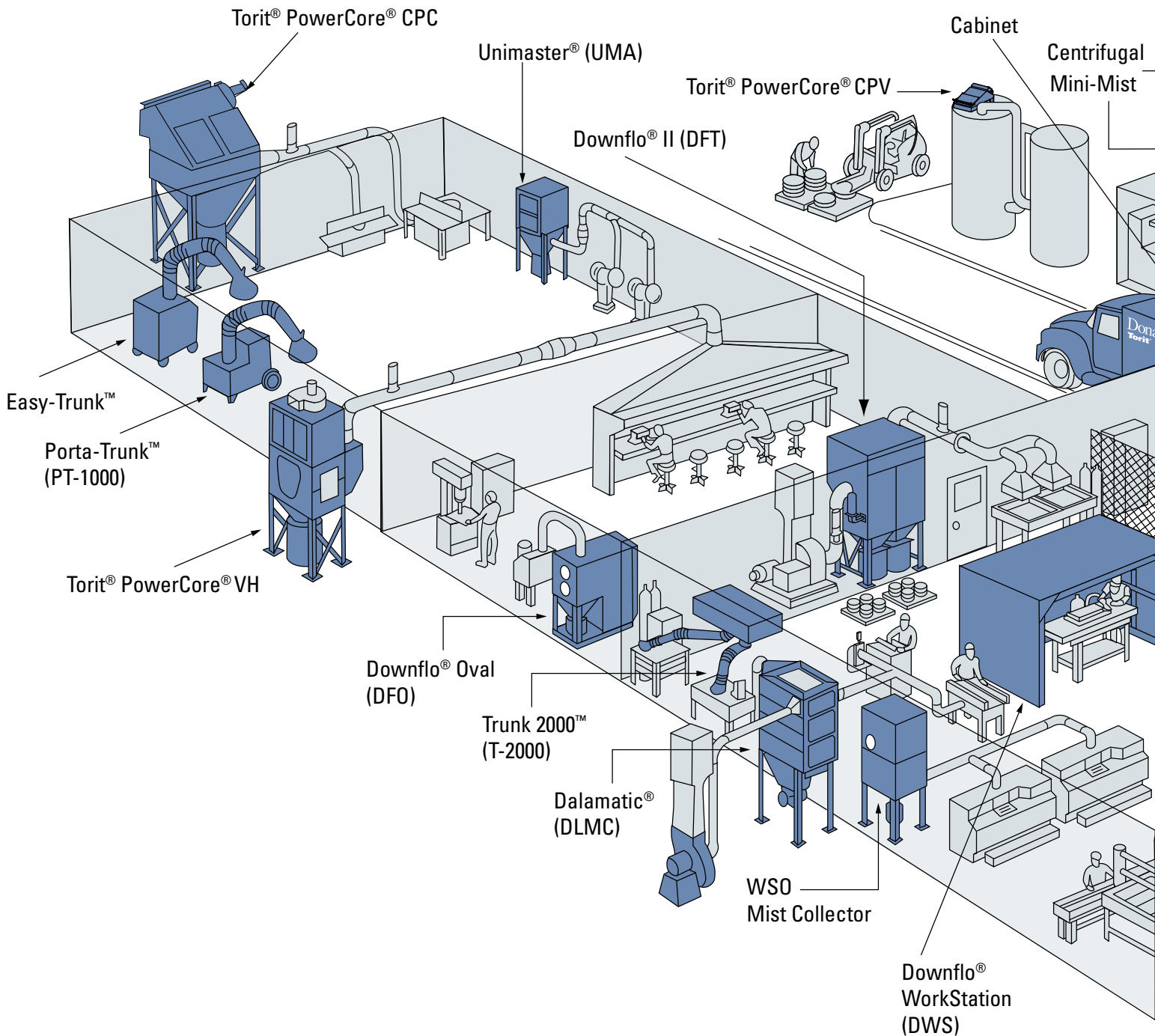

## OSHA & NFPA REQUIREMENTS

Donaldson® Torit® offers a variety of dust collectors, options, and accessories to help manufacturers comply with the collector sections of NFPA/OSHA standards on combustible dust. Contact a local Donaldson Representative, or call 800-365-1331, to schedule an on-site review of your filtration needs, and to determine what filtration equipment will support your course of action for NFPA/OSHA compliance on combustible dust.

# HELP PROTECT YOUR BOTTOM LINE

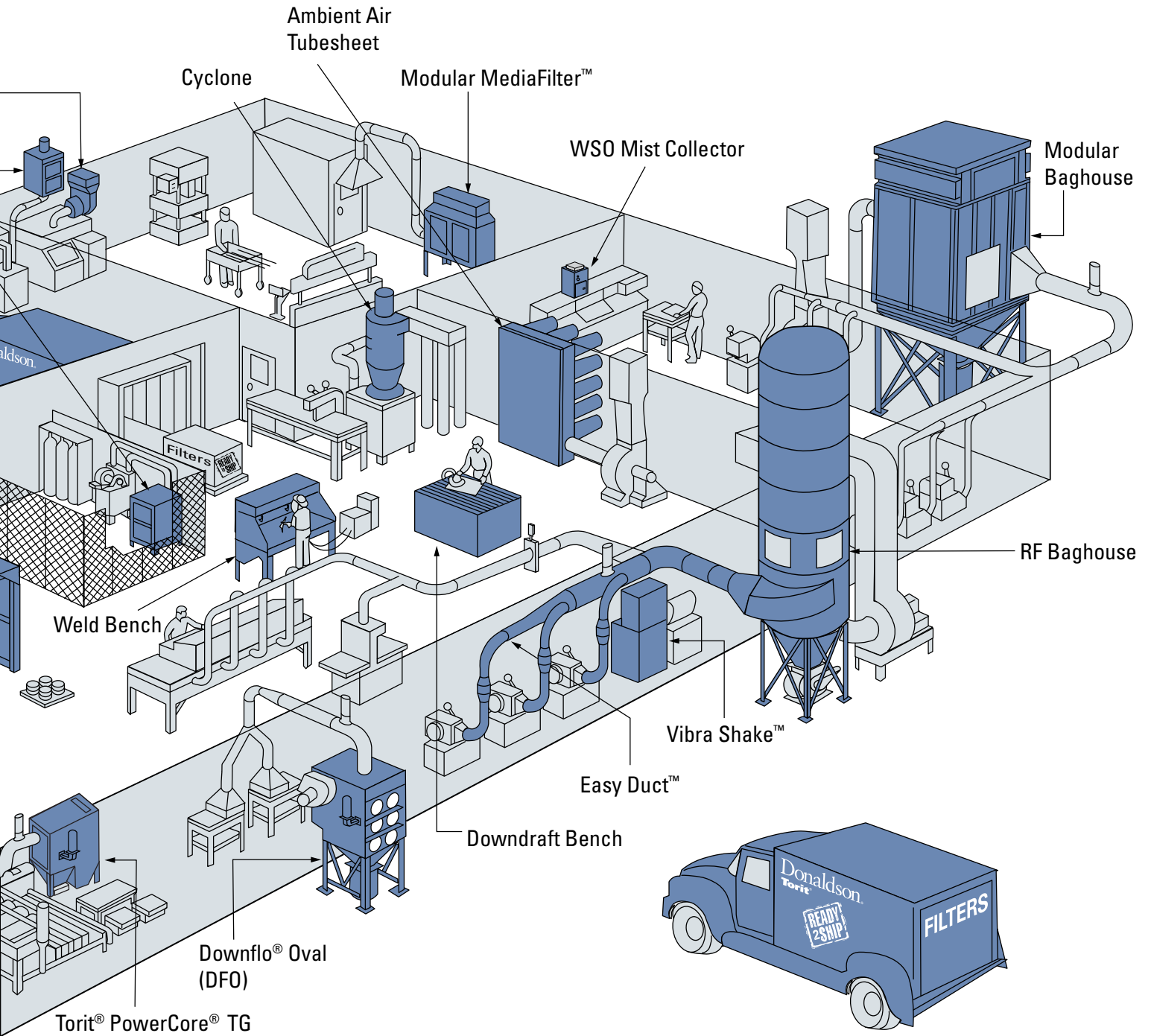

When employees are at their peak, so is productivity—and ultimately, a manufacturer's bottom line. Collectors and filters, expertly engineered by Donaldson Torit's unparalleled team of R&D engineers, provide long-term value rather than short-term savings.

# METALWORKING APPLICATIONS



**TG on Plasma Cutting**  
2,300 cfm (3,90 m<sup>3</sup>/h)



**DFO on Grinding**  
74,000 cfm (125,700 m<sup>3</sup>/h)



**DWS ON Custom Hand Grinding**  
38,500 cfm (65,398 m<sup>3</sup>/h)



**DFO on Plasma Cutting**  
5,000 cfm (8,493 m<sup>3</sup>/h)



**DFO on Welding Fumes**  
53,000 cfm (90,028 m<sup>3</sup>/h)  
Left: outside Right: inside



**DFO on Laser Cutting**  
3,100 cfm (5,266 m<sup>3</sup>/h)



**TG on Plasma Cutting**  
3,400 cfm (5,775 m<sup>3</sup>/h)



**DFO on Metal Grinding**  
31,000 cfm (52,658 m<sup>3</sup>/h)



**DFO & CYCLONE on Thermal Spray**  
4,800 cfm (8,154 m<sup>3</sup>/h)



**VH on Grinding**  
9,000 cfm (15,288 m<sup>3</sup>/h)



**DFO on Thermal Spray**  
8,500 cfm (14,439 m<sup>3</sup>/h)



**VH on Blasting**  
14,000 cfm (23,781 m<sup>3</sup>/h)



**DFO on Metallizing  
Powder Flame**  
20,500 cfm (34,822 m<sup>3</sup>/h)

# MIST APPLICATIONS



**DMC on Machining**  
800 cfm (1,359 m<sup>3</sup>/h)



**DMC on Wet Machining**  
390 cfm (662 m<sup>3</sup>/h)



**WSO on Oil Mist**  
20,000 cfm (33,973 m<sup>3</sup>/h)



**WSO - Horizontal Grinder**  
850 cfm (1,444 m<sup>3</sup>/h)



**WSO at M3 Achining Center**  
1,200 cfm (2,038 m<sup>3</sup>/h)



**WSO on Cold Forming**  
1,200 cfm (2,038 m<sup>3</sup>/h)



**MODULAR MEDIAFILTER™ on Grinding**  
2,000 cfm (3,397 m<sup>3</sup>/h)



# PROCESSING/POWDER & BULK APPLICATIONS



**DFT/CYCLONE on Paper Processing**  
5,300 cfm (9,003 m<sup>3</sup>/h)



**DFO on Rubber Grinding**  
2,500 cfm (4,247 m<sup>3</sup>/h)



**DFO on Paint & Pigment**  
1,200 cfm (2,038 m<sup>3</sup>/h)



**CPC on Milk Powder**  
1,200 cfm (2,038 m<sup>3</sup>/h)



**MB on Glass Processing**  
25,000 cfm (42,466 m<sup>3</sup>/h)



**DWS on Granite Finishing**  
22,000 cfm (37,370 m<sup>3</sup>/h)



**DLMC on Paper Dust**  
27,000 cfm (45,864 m<sup>3</sup>/h)



**DLMC on Rock Crushing**  
41,000 cfm (69,645 m<sup>3</sup>/h)

# GRAIN & NUT APPLICATIONS



**LP on Almond Dust**  
300,000 cfm (509,595 m<sup>3</sup>/h)



**CPV - Direct Bin Venting Distributor Head**  
2,400 cfm (4,077 m<sup>3</sup>/h)



**LP on Nut Dust**  
280,000 cfm (475,622 m<sup>3</sup>/h)



**RF - Grain Terminal**  
34,000 cfm (57,754 m<sup>3</sup>/h)



**CPC - Grain Tripper Conveyor**  
18,700 cfm (31,765 m<sup>3</sup>/h)



**RF - Grain Terminal**  
61,000 cfm (103,618 m<sup>3</sup>/h)



**DFO on Corn Husking & Sorting**  
28,500 cfm (48,412 m<sup>3</sup>/h)

# CEMENT APPLICATIONS



**CPV - Pneumatically Filled Storage Bin**  
1,200 cfm (2,038 m<sup>3</sup>/h)



**CPV - Weigh Belt Feeder**  
800 cfm (1,359 m<sup>3</sup>/h)



**CPV - Multiple Cement Silos**  
4,800 cfm (8,154 m<sup>3</sup>/h)



**CPV - Feed Hopper**  
350 cfm (595 m<sup>3</sup>/h)



**CPV - Multiple Cement Silos**  
4,800 cfm (8,154 m<sup>3</sup>/h)



**DFO - Concrete Roof Manufacturer**  
3,000 cfm (5,096 m<sup>3</sup>/h)



**CPV - Bucket Elevator**  
1,200 cfm (2,038 m<sup>3</sup>/h)

# WOODWORKING APPLICATIONS



**UMA - School Wood Shop**  
2,000 cfm (3,397 m<sup>3</sup>/h)



**CPC - Furniture Manufacturing**  
5,400 cfm (9,173 m<sup>3</sup>/h)



**FS on Woodworking**  
20,000 cfm (33,973 m<sup>3</sup>/h)



**DFO on Sawdust**  
57,500 cfm (97,692 m<sup>3</sup>/h)



**LP on Wood Dust**  
160,000 cfm (271,784 m<sup>3</sup>/h)



**RF - Cabinet Shop**  
48,500 cfm (82,385 m<sup>3</sup>/h)



**RF - Wood Furniture Facility**  
403,000 cfm (684,556 m<sup>3</sup>/h)



**IRD - Wood Shop**  
5,000 cfm (8,493 m<sup>3</sup>/h)

# ORIGINAL EQUIPMENT MANUFACTURERS

## CUSTOM SOLUTIONS FOR OEMS

OEMs have come to rely on Donaldson® Torit® to solve their filtration issues. Donaldson Torit offers flexible solutions customized to OEMs across a wide range of industries.

Donaldson Torit's reputation has been built on its problem solving, quality solutions, and commitment to customers' satisfaction even after the sale. And Donaldson Torit's worldwide network allows it to provide local support that's responsive and comprehensive – no matter where it's needed.

A dedicated team of OEM account managers and engineers stands ready to solve even the most complex filtration issue.



### MOBILE MINING APPLICATION

Donaldson Torit can design solutions to accommodate customer space constraints and integrate additional filtration technologies tailored to customer needs.



### RAIL GRINDING

Custom designs that accommodate unique customer space constraints are available.

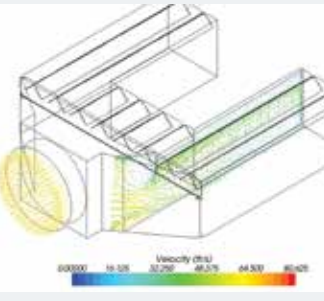

### AIRFLOW MODELING ABRASION MODELING STRUCTURAL ANALYSIS

Only Donaldson Torit provides sophisticated engineering analysis tools to ensure proper airflow management, extended filter life, and reduced maintenance costs.



### PLASMA CUTTING

Donaldson Torit engineers can provide a unique, integral pre-separator for spark reduction in laser and plasma cutting.

# ANCILLARY PRODUCTS & REPLACEMENT PARTS

## COMPLETING THE FILTRATION SYSTEM

Donaldson® Torit® understands that high performance dust, fume and mist collectors are just the first step in keeping plants cleaner and more productive. Donaldson Torit's high performance ancillary products quickly and cost-effectively complete the system, whether a manufacturer is installing a new filtration system or expanding an existing filtration line.



### EASY DUCT™

Easy Duct ductwork eliminates time-consuming operations like riveting, cutting, brazing, and welding for standard length piping. Easy Duct can be assembled and taken apart with no special tools, saving ducting each time a floor plan changes.



### DELTA P AND DELTA P PLUS CONTROLS

Delta P or Delta P Plus Controls are a key element of dust collector maintenance, measuring pressure drop across the filters to determine when servicing is needed. Recommended for all continuous-duty dust collection systems, Delta P monitors pressure drop so that filters are cleaned only when necessary, reducing compressed air usage and prolonging filter life.

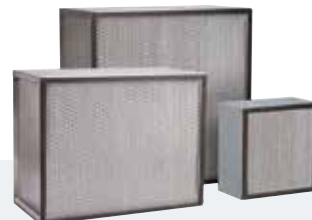

### HEPA & 95% DOP FILTERS

Providing a high filtration efficiency of 99.97% at 0.3 microns, HEPA filters can be used as afterfilters for dust, fume and mist collection. Also available are panel filters with 95% DOP media or 95% ASHRAE media.



### ROTARY VALVES

Rotary Valves offer an economical solution for automated handling of most discharge dust. Available in three models: high pressure, low pressure, and sweeper valves. Rotary valves provide continuous dust disposal that keeps hoppers and collectors operating at peak performance, thereby reducing dust collector maintenance time and cost.



### FANS

**Torit Backward Inclined (TBI)** direct drive fans are available in sizes ranging from 3 hp to 30 hp. The TBI fan mounts directly to the clean-air plenum of the dust collector, eliminating costly transition ducting. **Torit Radial Blade (TRB)** fans are an economical, dependable radial fan with a direct-drive design to eliminate maintenance on fan bearings and belts. The TRB is available in sizes from 1 hp to 10 hp.

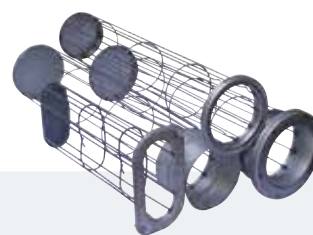

### CAGES

Replacement cages are available for Donaldson Torit baghouse collectors as well as many other popular makes and models. Cages are available in galvanized or stainless steel for ambient, high temperature, or highly corrosive environments.

# REPLACEMENT FILTERS

## COMPREHENSIVE OFFERING FOR A VARIETY OF EQUIPMENT BRANDS



Using Donaldson® Torit® replacement filters can significantly improve the performance of dust collectors. Uniquely engineered for longer filter life and higher filtration efficiency, Donaldson Torit cartridge and bag filters are the most cost-effective choice for any collector and any application.

Rely on Donaldson Torit for all popular brands of collectors. With hundreds of varieties to choose from and all in-stock orders shipped within 24 hours, Donaldson Torit has exactly what you need when you need it!

No other filter manufacturer can match Donaldson Torit's technical expertise and commitment. For knowledgeable support and to determine the right filters for a specific application, call Donaldson Torit's customer service representatives at 800-365-1331 or visit [www.donaldsonorit.com](http://www.donaldsonorit.com)

### **DURA-LIFE™** for baghouse collectors

- AZO®
- Buhler
- Carter Day
- DCE
- Flex-Kleen
- Golfetto
- Kice
- MAC
- MikroPul
- Murphy
- Pneumafil
- Steelcraft®
- Wheelabrator
- + Many others



### **ULTRA-WEB®** for cartridge collectors

- AAF®
- Aercology®
- Airflow® Systems
- Clemco®
- Environmental Systems Designs
- Farr
- Geoff
- MAC
- Micro Air®
- Nordson
- Pneumafil
- Robovent®
- Steelcraft®
- Trion®
- UAS®
- Wheelabrator
- + Many others

**CALL 800-365-1331 FOR LIVE SUPPORT**  
**VISIT DONALDSONTORIT.COM**

## Global Support

- Facilities in 37 countries
- 40 manufacturing plants and 14 distribution centers

## Leading Technology

- Over 1,000 engineers and scientists worldwide
- Broad range of innovative collectors and filters
- 100s of filter media formulations

## Experience and Service

- Technical expertise and support
- Ready-to-ship filters and parts within 24 hours

Call Donaldson® Torit® to get cleaner air today:

**800-365-1331**

[DonaldsonTorit.com](http://DonaldsonTorit.com)



**Donaldson**  
FILTRATION SOLUTIONS

Tel 800-365-1331 (USA)  
Tel 800-343-3639 (within Mexico)  
[donaldsontorit@donaldson.com](mailto:donaldsontorit@donaldson.com)  
[donaldsontorit.com](http://donaldsontorit.com)

Donaldson Company, Inc.  
Torit  
P.O. Box 1299  
Minneapolis, MN  
55440-1299 U.S.A.

**EXACTLY WHAT YOU NEED.™**

**General Brochure (10/13)**

© 2010 Donaldson Company, Inc. All Rights Reserved. Information in this document is subject to change without notice. Donaldson Torit, Torit PowerCore, Ultra-Web, and the color blue are registered trademarks of Donaldson Company, Inc. Contains Donaldson proprietary technology.